

MILA GARANT espags



- espags
- brakes
- accessory

www.mila.dk

 **MILA**
Quality & service | It's in our DNA

1. GENEREL INFORMATION

General Information

2. GARANT KOLVE- OG MINIHAGE-PASKVILLER

GARANT Tongue and Mini Hook Espags

3. BREMSER OG TILBEHØR

Brakes and Accessories

4. GARANT RULLEPASKVILLER M. SI-TAP

Garant Mushroom Espags

5. MONTERINGSVEJLEDNING

Mounting Instruction

6. VEDLIGEHOLDELSERVEJLEDNING

Maintenance Instruction

EGNE NOTATER

Notes

GENERELT

General info

1.

LÅSEKASSE

Grebshul 7 mm.

Skrueafstand 43 mm.

5 mm gevindhuller for grebsbefæstigelse.

Låsekassedybde:
Dornmål + 8 mm

Låsekasserne er forsynede med RBS*, hvilket vil sige, at kolverne/rullerne i lukket stilling kun kan betjenes via grebet.

* Reverse Blocking System

KOLVER

Kolvefremspring: 12 og 15 mm.

Kolvefremspring minihager: 14,6 mm

Lock Case

Handle hole 7mm.

Screw distance 43 mm.

5 mm thread holes for handle fixation.

Depth of lock case:
Backset measure + 8 mm

The lock cases are equipped with RBS* which means that tongues in locked position can be operated through the handle only.

* Reverse Blocking System

Tongues

Tongue projection 12 and 15 mm.

Mini hooks projection 14,6 mm

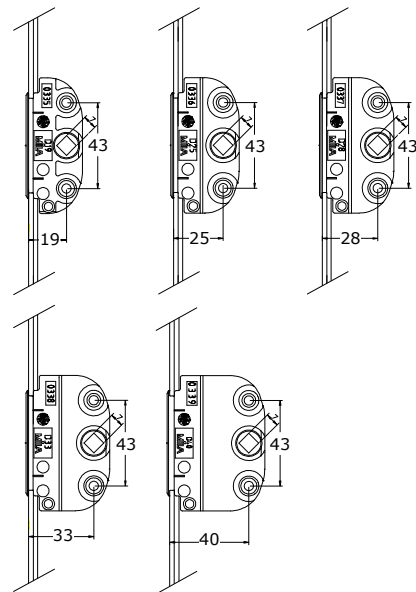

DORN / BACKSET
19, 25, 28, 33, 40 MM

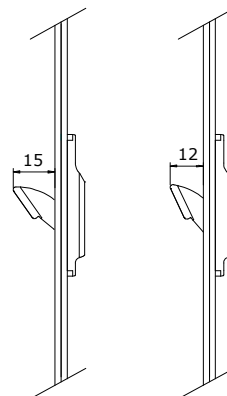

KOLVEFREMSPRING
TONGUE PROJECTION
12 OG 15 MM

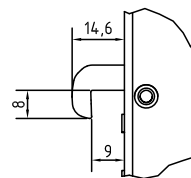

KOLVEFREMSPRING - MINI HAGE
TONGUE PROJECTION - MINI HOOK
14,6 MM

KOLVEPASKVILLER

Tongue Espags

2.

KOLVEPASKVIL STR. 1

16 mm fladstolpe, sølv finish. Låsekasse i støbt zink. 7 mm grebshul.

Tandstang i top for kobling med bremse. Kolvefremspring 12 eller 15 mm. Grebsplacering kan forsættes fra midten ved hjælp af mellemstykker.

Dornmål 19, 25, 28 eller 33.

Paskvillen er forsynet med RBS, hvilket vil sige, at kolverne i lukket stilling kun kan betjenes via grebet.

Anvendelsesområde:

Uden bremseoverføring

298–400 mm. Forsat grebshøjde 156 mm.

293–500 mm. Grebsplacering midte.

Med bremseoverføring

406–470 mm. Forsat grebshøjde 156 mm.

500–632 mm. Grebsplacering midte.

Tongue Espag Size 1

16 mm faceplate, silver finish. Lock case zinc alloy casting. 7 mm handle hole.

Serrated rod for brake at top.

Tongue travel 12 or 15 mm. Handle position can be offset by means of connectors.

Backset 19, 25, 28 and 33.

The espag is equipped with RBS which means that tongues in locked position can be operated through the handle only.

Size Range:

Without brake connector

298–400 mm. Offset handle height 156 mm.

293–500 mm. Central handle position.

With brake connector

406–470 mm. Offset handle height 156 mm.

500–632 mm. Central handle position.

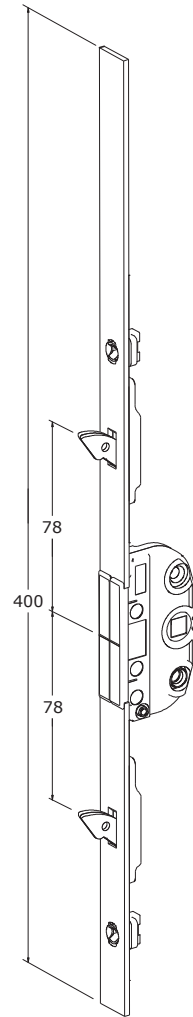

| ARTIKELNR. | | |
|--------------------|-------------------------|-------------------------|
| Dornmål Backset | Kolve / Tongue 12 mm | Kolve / Tongue 15 mm |
| 19 | 038000 | 038120 |
| 25 | 038040 | 038160 |
| 28 | 038060 | 038180 |
| 33 | 038080 | 038200 |

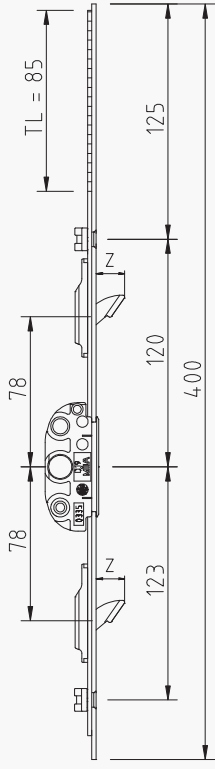

KOLVEPASKVIL STR. 2

16 mm fladstolpe, sølv finish. Låsekasse i støbt zink. 7 mm grebshul.

Tandstang i top og bund for kobling med bremse. Kolvefremspring 12 eller 15 mm. Grebsplace-ring kan forsættes fra midten ved hjælp af mellemstykker.

Dornmål 19, 25, 28 eller 33.

Paskvillen er forsynet med RBS, hvilket vil sige, at kolverne i lukket stilling kun kan betjenes via grebet.

Anvendelsesområde:

390–690 mm (uden bremseoverføring).

602–830 mm (med bremseoverføring).

Tongue Espag Size 2

16 mm faceplate, silver finish. Lock case zinc alloy casting. 7 mm handle hole.

Serrated rod for brake both at top and bottom.

Tongue travel 12 or 15 mm. Handle position can be offset by means of connectors.

Available in 19, 25, 28 and 33 mm backset.

The espag is equipped with RBS which means that tongues in locked position can be operated through the handle only.

Size Range:

390–690 mm (without brake connector).

602–830 mm (with brake connector).

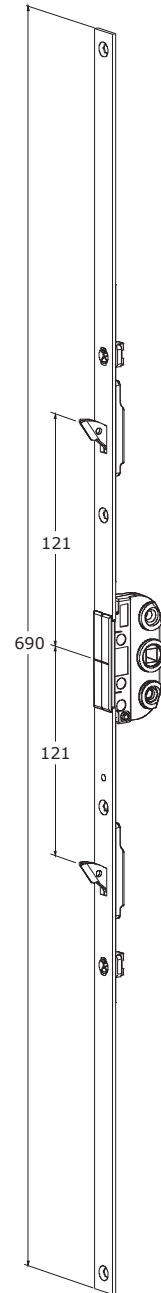

| ARTIKELNR. | | |
|--------------------|-------------------------|-------------------------|
| Dornmål Backset | Kolve / Tongue 12 mm | Kolve / Tongue 15 mm |
| 19 | 038002 | 038122 |
| 25 | 038042 | 038162 |
| 28 | 038062 | 038182 |
| 33 | 038082 | 038202 |

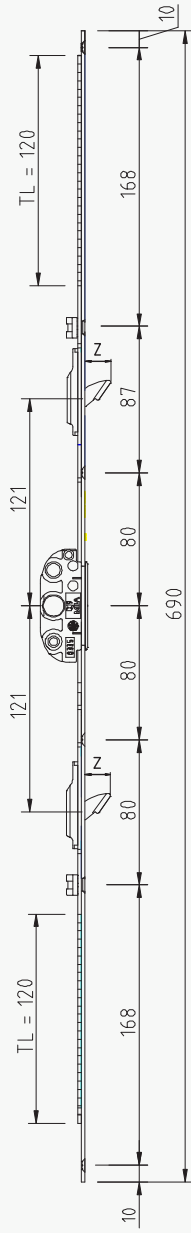

KOLVESPASKVIL STR. 3

16 mm fladstolpe, sølv finish. Låsekasse i støbt zink. 7 mm grebshul.

Tandstang i top og bund for kobling med bremse. Kolvefremspring 12 eller 15 mm. Grebsplacering kan forsættes fra midten ved hjælp af mellemstykker.

Dornmål 19, 25, 28 eller 33.

Paskvillen er forsynet med RBS, hvilket vil sige, at kolverne i lukket stilling kun kan betjenes via grebet.

Anvendelsesområde:

590– 890 mm (uden bremseoverføring).

810–1020 mm (med bremseoverføring).

Rammeløfter kan monteres.

Tongue Espag Size 3

16 mm faceplate, silver finish. Lock case zinc alloy casting. 7 mm handle hole.

Serrated rod for brake both at top and bottom.

Tongue travel 12 or 15 mm. Handle position can be offset by means of connectors.

Available in 19, 25, 28 and 33 mm backset.

The espag is equipped with RBS which means that tongues in locked position can be operated through the handle only.

Size Range:

590– 890 mm (without brake connector).

810–1020 mm (with brake connector).

Sash lift optional.

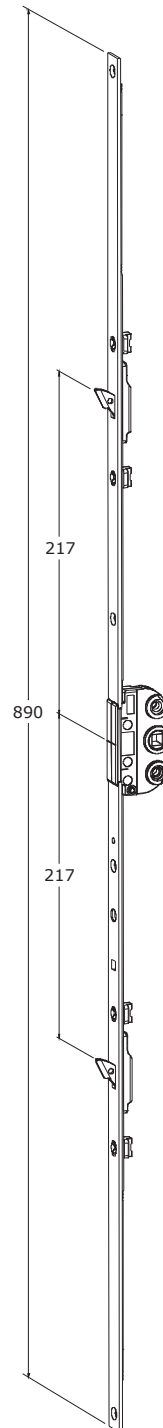

| ARTIKELNR. | | |
|--------------------|-------------------------|-------------------------|
| Dornmål Backset | Kolve / Tongue 12 mm | Kolve / Tongue 15 mm |
| 19 | 038004 | 038124 |
| 25 | 038044 | 038164 |
| 28 | 038064 | 038184 |
| 33 | 038084 | 038204 |

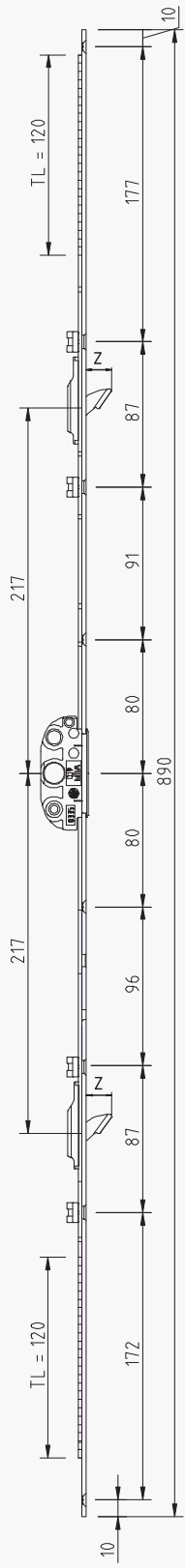

KOLVESPASKVIL STR. 4

16 mm fladstolpe, sølv finish. Låsekasse i støbt zink. 7 mm grebshul.

Tandstang i top og bund for kobling med bremse. Kolvefremspring 12 eller 15 mm. Grebsplacering kan forsættes fra midten ved hjælp af mellemstykker.

Dornmål 19, 25, 28 eller 33.

Paskvillen er forsynet med RBS, hvilket vil sige, at kolverne i lukket stilling kun kan betjenes via grebet.

Anvendelsesområde:

800–1090 mm (uden bremseoverføring).

1010–1210 mm (med bremseoverføring).

Rammeløfter kan monteres.

Tongue Espag Size 4

16 mm faceplate, silver finish. Lock case zinc alloy casting. 7 mm handle hole.

Serrated rod for brake both at top and bottom.

Tongue travel 12 or 15 mm. Handle position can be offset by means of connectors.

Available in 19, 25, 28 and 33 mm backset.

The espag is equipped with RBS which means that tongues in locked position can be operated through the handle only.

Size Range:

800–1090 mm (without brake connector).

1010–1210 mm (with brake connector).

Sash lift optional.

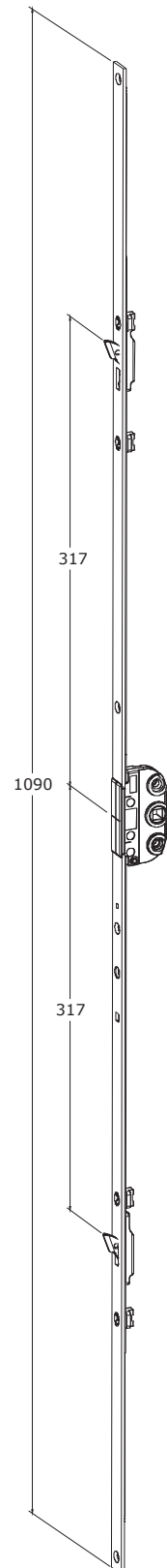

| ARTIKELNR. | | |
|--------------------|-------------------------|-------------------------|
| Dornmål Backset | Kolve / Tongue 12 mm | Kolve / Tongue 15 mm |
| 19 | 038006 | 038126 |
| 25 | 038046 | 038166 |
| 28 | 038066 | 038186 |
| 33 | 038086 | 038206 |

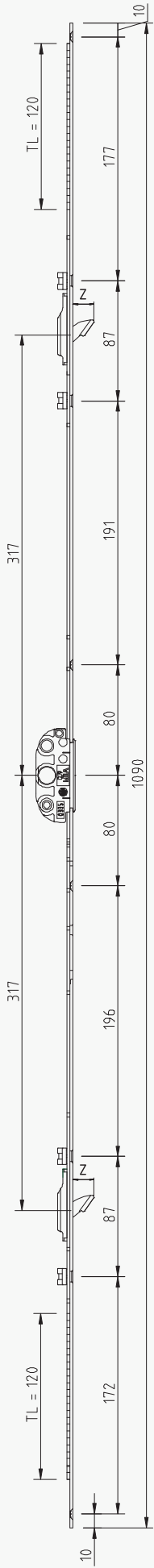

KOLVEPASKVIL STR. 5 / 5A

16 mm fladstolpe, sølv finish. Låsekasse i støbt zink. 7 mm grebshul.

Tandstang i top og bund for kobling med bremse. Denne størrelse fås i 2 udgaver med henholdsvis 2 og 3 kolver. Kolvefremspring 12 eller 15 mm. Grebsplacering kan forsættes fra midten ved hjælp af mellemstykker.

Dornmål 19, 25, 28 eller 33.

Paskvillen er forsynet med RBS, hvilket vil sige, at kolverne i lukket stilling kun kan betjenes via grebet.

Anvendelsesområde:

1000–1290 mm (uden bremseoverføring).

1210–1410 mm (med bremseoverføring).

Rammeløfter kan monteres.

Tongue Espag Size 5 / 5A

16 mm faceplate, silver finish. Lock case zinc alloy casting. 7 mm handle hole.

Serrated rod for brake both at top and bottom.

This size is available with both 2 and 3 tongues. Tongue travel 12 or 15 mm. Handle position can be offset by means of connectors.

Available in 19, 25, 28 and 33 mm backset.

The espag is equipped with RBS which means that tongues in locked position can be operated through the handle only.

Size Range:

1000–1290 mm (without brake connector).

1210–1410 mm (with brake connector).

Sash lift optional.

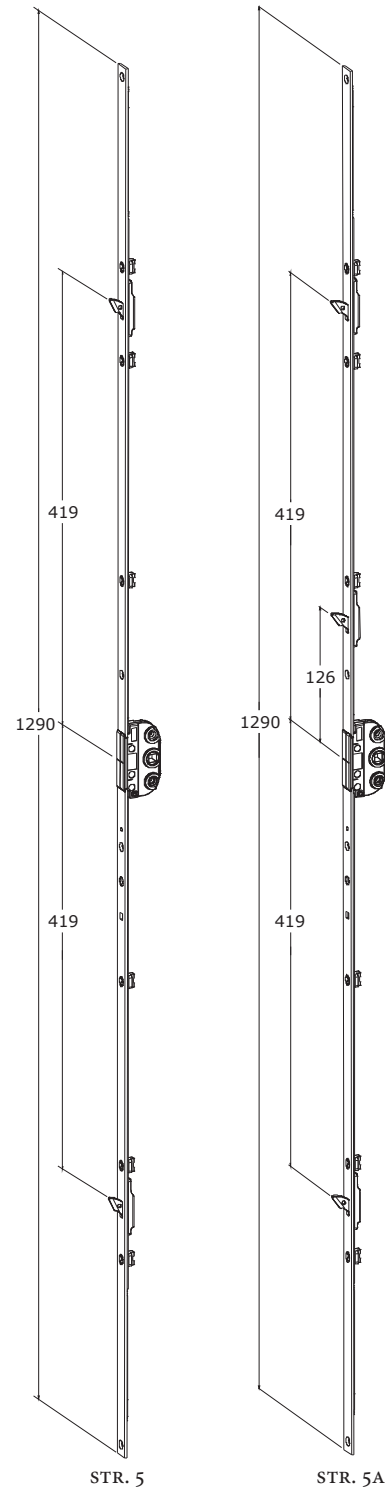

STR. 5

STR. 5A

| ARTIKELNR. | | | | |
|-----------------|------------------------------|------------------------------|------------------------------|------------------------------|
| Dornmål Backset | Kolve 12 mm 2 kolver/tongues | Kolve 12 mm 3 kolver/tongues | Kolve 15 mm 2 kolver/tongues | Kolve 15 mm 3 kolver/tongues |
| 19 | 038008 | 038009 | 038128 | 038129 |
| 25 | 038048 | 038049 | 038168 | 038169 |
| 28 | 038068 | 038069 | 038188 | 038189 |
| 33 | 038088 | 038089 | 038208 | 038209 |

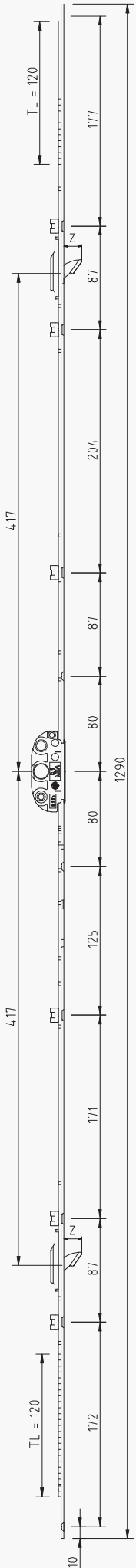

STR. 5

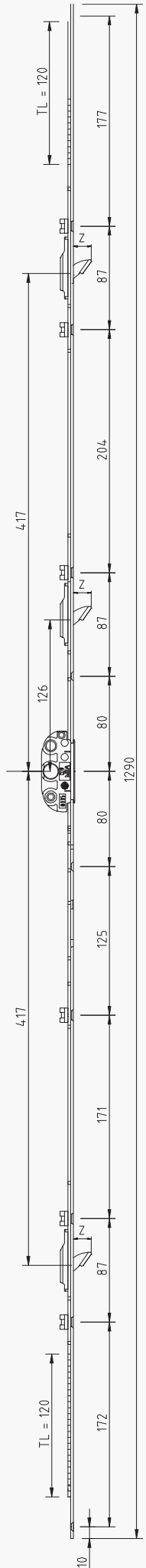

STR. 5A

KOLVESPASKVIL STR. 6

16 mm fladstolpe, sølv finish. Låsekasse i støbt zink. 7 mm grebshul.

Tandstang i top og bund for kobling med bremse. Kolvefremspring 12 eller 15 mm. Grebsplacering kan forsættes fra midten ved hjælp af mellemstykker.

Dornmål 19, 25, 28 eller 33.

Paskvillen er forsynet med RBS, hvilket vil sige, at kolverne i lukket stilling kun kan betjenes via grebet.

Anvendelsesområde:

1200–1490 mm (uden bremseoverføring).

1410–1610 mm (med bremseoverføring).

Rammeløfter kan monteres.

Tongue Espag Size 6

16 mm faceplate, silver finish. Lock case zinc alloy casting. 7 mm handle hole.

Serrated rod for brake both at top and bottom.

Tongue travel 12 or 15 mm. Handle position can be offset by means of connectors.

Available in 19, 25, 28 and 33 mm backset.

The espag is equipped with RBS which means that tongues in locked position can be operate through the handle only.

Size Range:

1200–1490 mm (without brake connector).

1410–1610 mm (with brake connector).

Sash lift optional.

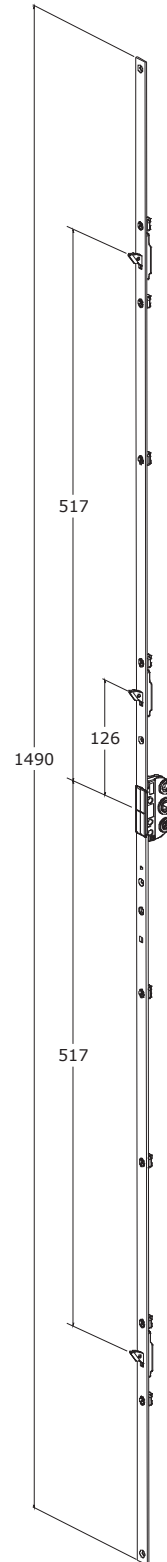

| ARTIKELNR. | | |
|--------------------|-------------------------|-------------------------|
| Dornmål Backset | Kolve / Tongue 12 mm | Kolve / Tongue 15 mm |
| 19 | 038010 | 038130 |
| 25 | 038050 | 038170 |
| 28 | 038070 | 038190 |
| 33 | 038090 | 038210 |

KOLVESPASKVIL STR. 7

16 mm fladstolpe, sølv finish. Låsekasse i støbt zink. 7 mm grebshul.

Tandstang i top og bund for kobling med bremse. Kolvefremspring 12 eller 15 mm. Grebsplacering kan forsættes fra midten ved hjælp af mellemstykker.

Dornmål 19, 25, 28 eller 33.

Paskvillen er forsynet med RBS, hvilket vil sige, at kolverne i lukket stilling kun kan betjenes via grebet.

Anvendelsesområde:

1400–1690 mm (uden bremseoverføring).

1610–1810 mm (med bremseoverføring).

Rammeløfter kan monteres.

Tongue Espag Size 7

16 mm faceplate, silver finish. Lock case zinc alloy casting. 7 mm handle hole.

Serrated rod for brake both at top and bottom.

Tongue travel 12 or 15 mm. Handle position can be offset by means of connectors.

Available in 19, 25, 28 and 33 mm backset.

The espag is equipped with RBS which means that tongues in locked position can be operate through the handle only.

Size Range:

1400–1690 mm (without brake connector).

1610–1810 mm (with brake connector).

Sash lift optional.

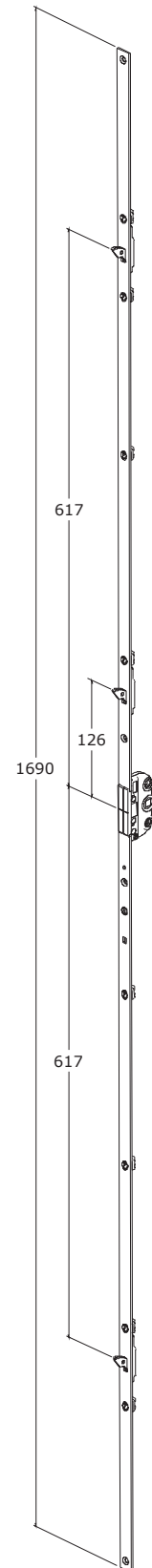

| ARTIKELNR. | | |
|--------------------|-------------------------|-------------------------|
| Dornmål Backset | Kolve / Tongue 12 mm | Kolve / Tongue 15 mm |
| 19 | 038012 | 038132 |
| 25 | 038052 | 038172 |
| 28 | 038072 | 038192 |
| 33 | 038092 | 038212 |

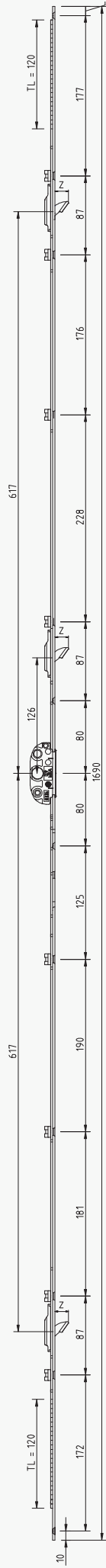

KOLVEPASKVIL STR. 8

16 mm fladstolpe, sølv finish. Låsekasse i støbt zink. 7 mm grebshul.

Tandstang i top og bund for kobling med bremse. Kolvefremspring 12 eller 15 mm. Grebsplacering kan forsættes fra midten ved hjælp af mellemstykker.

Dornmål 19, 25, 28 eller 33.

Paskvillen er forsynet med RBS, hvilket vil sige, at kolverne i lukket stilling kun kan betjenes via grebet.

Anvendelsesområde:

1600–1890 mm (uden bremseoverføring).

1810–2010 mm (med bremseoverføring).

Rammeløfter kan monteres.

Tongue Espag Size 8

16 mm faceplate, silver finish. Lock case zinc alloy casting. 7 mm handle hole.

Serrated rod for brake both at top and bottom.

Tongue travel 12 or 15 mm. Handle position can be offset by means of connectors.

Available in 19, 25, 28 and 33 mm backset.

The espag is equipped with RBS which means that tongues in locked position can be operate through the handle only.

Size Range:

1600–1890 mm (without brake connector).

1810–2010 mm (with brake connector).

Sash lift optional.

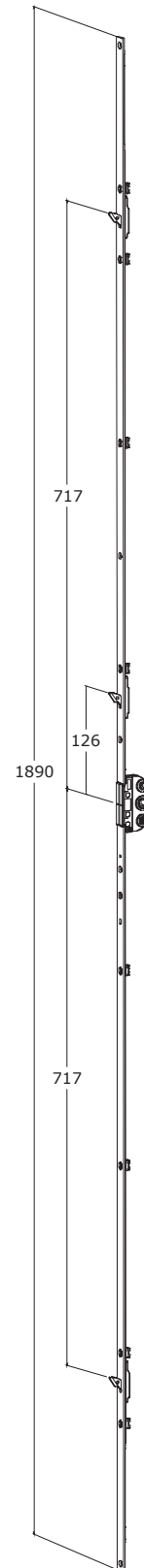

| ARTIKELNR. | | |
|--------------------|-------------------------|-------------------------|
| Dornmål Backset | Kolve / Tongue 12 mm | Kolve / Tongue 15 mm |
| 19 | 038014 | 038134 |
| 25 | 038054 | 038174 |
| 28 | 038074 | 038194 |
| 33 | 038094 | 038214 |

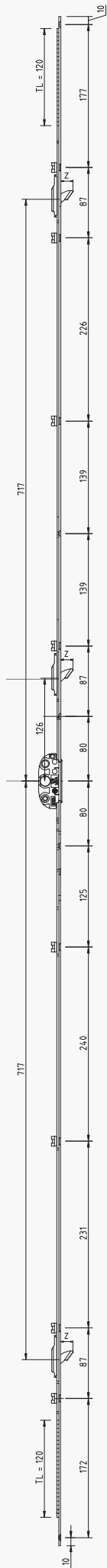

KOLVEPASKVIL STR. 9

16 mm fladstolpe, sølv finish. Låsekasse i støbt zink. 7 mm grebshul.

Tandstang i top for kobling med bremse. Kolvefremspring 12 eller 15 mm. Grebsplacering kan forsættes fra midten ved hjælp af mellemstykker.

Dornmål 19, 25, 28 , 33 eller 40 mm.

Paskvillen er forsynet med RBS, hvilket vil sige, at kolverne i lukket stilling kun kan betjenes via grebet.

Anvendelsesområde:

1900–2100 mm (uden bremseoverføring).

1920–2160 mm (med bremseoverføring).

Rammeløfter kan monteres.

Tongue Espag Size 9

16 mm faceplate, silver finish. Lock case zinc alloy casting. 7 mm handle hole.

Serrated rod for brake at the top.

Tongue travel 12 or 15 mm. Handle position can be offset by means of connectors.

Available in 19, 25, 28, 33 and 40 mm backset.

The espag is equipped with RBS which means that tongues in locked position can be operated through the handle only.

Size Range:

1900–2100 mm (without brake connector).

1920–2160 mm (with brake connector).

Sash lift optional.

| ARTIKELNR. | | |
|--------------------|-------------------------|-------------------------|
| Dornmål Backset | Kolve / Tongue 12 mm | Kolve / Tongue 15 mm |
| 19 | 038016 | 038136 |
| 25 | 038056 | 038176 |
| 28 | 038076 | 038196 |
| 33 | 038096 | 038216 |
| 40 | 038116 | 038236 |

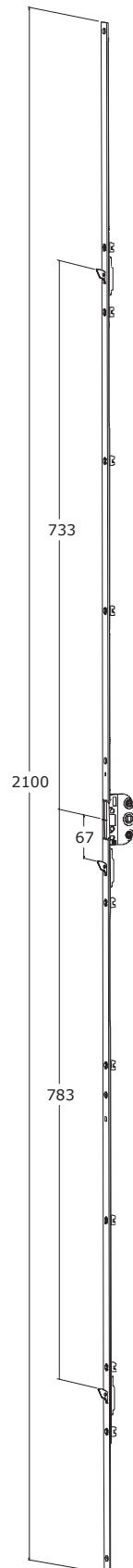

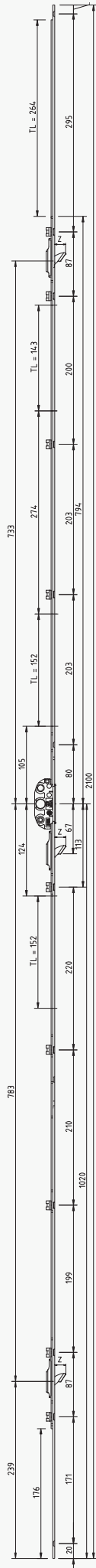

KOLVEPASKVIL STR. 10

16 mm fladstolpe, sølv finish. Låsekasse i støbt zink. 7 mm grebshul.

Tandstang i top for kobling med bremse. Kolvefremspring 12 eller 15 mm. Grebsplacering kan forsættes fra midten ved hjælp af mellemstykker.

Dornmål 19, 25, 28, 33 eller 40 mm.

Paskvillen er forsynet med RBS, hvilket vil sige, at kolverne i lukket stilling kun kan betjenes via grebet.

Anvendelsesområde:

2100–2300 mm (uden bremseoverføring).

2145–2360 mm (med bremseoverføring).

Rammeløfter kan monteres.

Tongue Espag Size 10

16 mm faceplate, silver finish. Lock case zinc alloy casting. 7 mm handle hole.

Serrated rod for brake at the top.

Tongue travel 12 or 15 mm. Handle position can be offset by means of connectors.

Available in 19, 25, 28, 33 and 40 mm backset.

The espag is equipped with RBS which means that tongues in locked position can be operated through the handle only.

Size Range:

2100–2300 mm (without brake connector).

2145–2360 mm (with brake connector).

Sash lift optional.

| ARTIKELNR. | | |
|--------------------|-------------------------|-------------------------|
| Dornmål Backset | Kolve / Tongue 12 mm | Kolve / Tongue 15 mm |
| 19 | 038018 | 038138 |
| 25 | 038058 | 038178 |
| 28 | 038078 | 038198 |
| 33 | 038098 | 038218 |
| 40 | 038118 | 038238 |

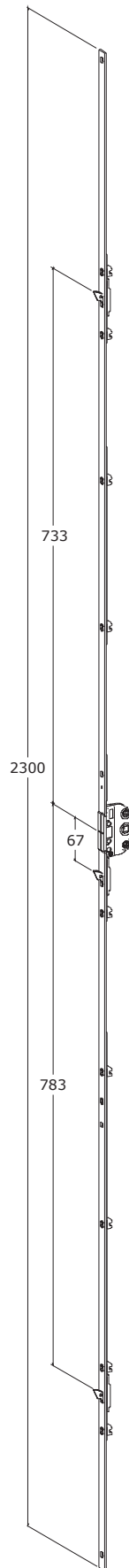

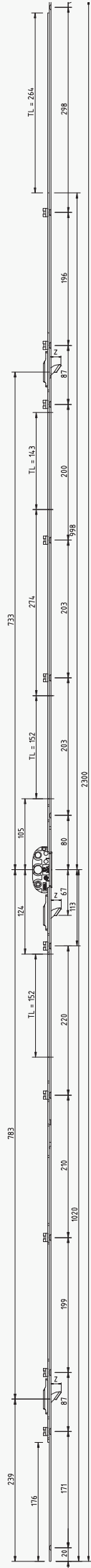

KOLVEPASKVIL STR. 2E, 4E OG 4H

Specialudgave af str. 2 og 4 med lang fortanding for yderligere afkortnings- og kombinationsmuligheder.

16 mm fladstolpe, sølv finish. Låsekasse i støbt zink. 7 mm grebshul. Dornmål 25 og 28.

Tandstang i top og bund for kobling med forlænger- og endestykker og bremses. Str. 2E og 4H er uden kolver, str. 4E har 1 kolve. Kolvefremspring 12 eller 15 mm. Grebsplacering kan forsættes fra midten ved hjælp af mellemstykker.

Paskvillen er forsynet med RBS, hvilket vil sige, at kolverne i lukket stilling kun kan betjenes via grebet.

Anvendelsesområde:
(med bremseoverføring/endestykker)

2E: 640–1040 mm

4E: 975–1640 mm

4H: 975–1640 mm

Tongue Espag Size 2E, 4E and 4H

Special execution of size 2 and 4 with long serrated rod for additional shortening and combination options.

16 mm faceplate, silver finish. Lock case zinc alloy casting. 7 mm handle hole. 25 and 28 mm backset.

Serrated rod at both top and bottom for coupling to connectors and brakes. Size 2E and 4H is without tongues, size 4E has one tongue. Tongue travel 12 or 15 mm. Handle position can be offset by means of connectors.

The espag is equipped with RBS which means that tongues in locked position can be operated through the handle only.

Size Range:
(with brakes / connectors)

2E: 640–1040 mm

4E: 975–1640 mm

4H: 975–1640 mm

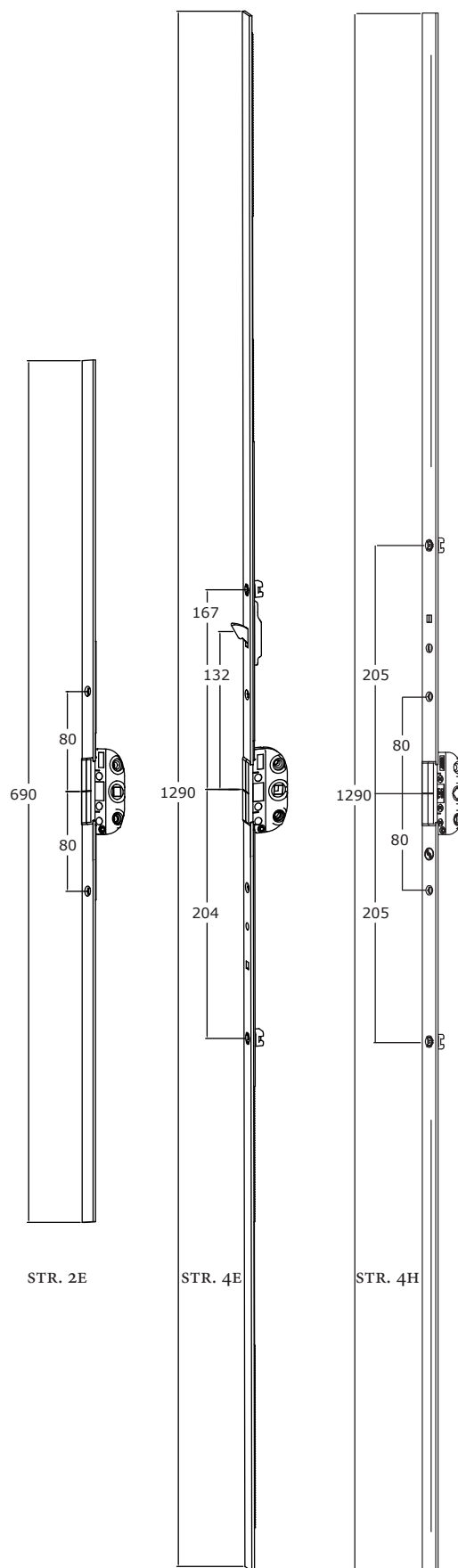

| ARTIKELNR. | | | | | |
|-----------------|----------------------------|----------------------------|----------------------------|----------------------------|----------------------------|
| Dornmål Backset | Str. 2E kolve/tongue 12 mm | Str. 2E kolve/tongue 15 mm | Str. 4E kolve/tongue 12 mm | Str. 4E kolve/tongue 15 mm | Str. 4H kolve/tongue 15 mm |
| 25 | 038242 | 038244 | 038243 | 038245 | |
| 28 | 038250 | 038252 | 038251 | 038253 | 038254 |

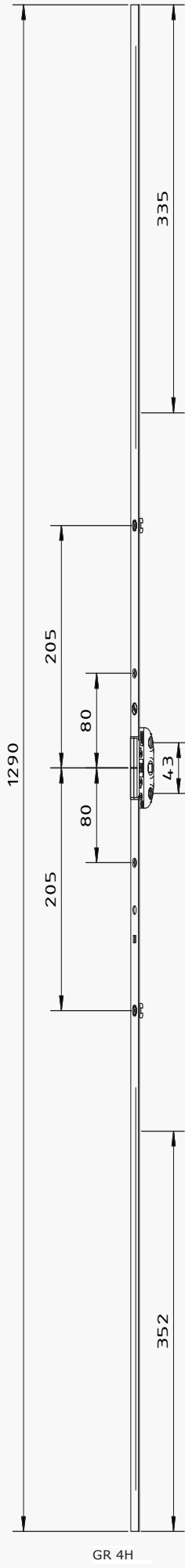
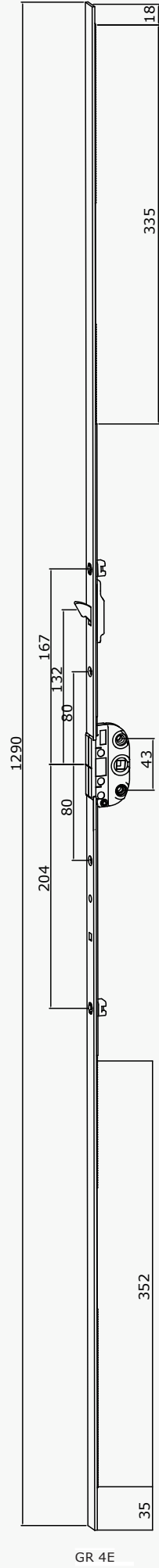
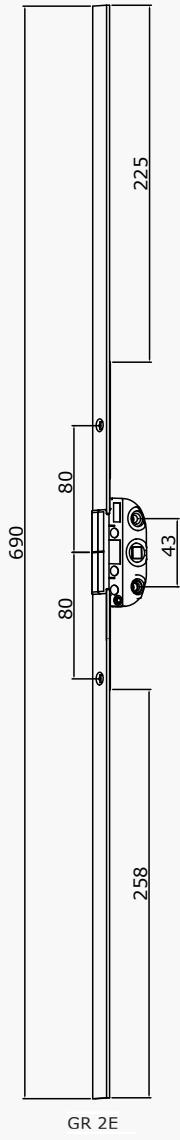

MINIHAGE-PASKVIL STR. 0

Specialudgave med minihager.

16 mm fladstolpe, sølv finish. Låsekasse i støbt zink. 7 mm grebshul. Dornmål 28.

Tandstang i top og bund for kobling med forlænger- og endestykker og bremser. Kolvefremspring 14,6 mm. Grebsplacering kan forsættes fra midten ved hjælp af mellemstykker.

Paskvillen er forsynet med RBS, hvilket vil sige, at kolverne i lukket stilling kun kan betjenes via grebet.

Anvendelsesområde:

Uden bremseoverføring:

410 - 639 mm

Med bremseoverføring:

520 - 705 mm

Mini Hook Espag Size 0

Special execution with mini hooks.

16 mm faceplate, silver finish. Lock case zinc alloy casting. 7 mm handle hole. 28 mm backset.

Serrated rod at top for coupling to connectors and brakes. Tongue travel 14,6 mm. Handle position can be offset by means of connectors.

The espag is equipped with RBS which means that tongues in locked position can be operated through the handle only.

Size Range:

Without brake connector:

410- 639 mm

With brake connector:

520 - 705 mm

| ARTIKELNR. | |
|--------------------|----------------------------------|
| Dornmål Backset | Str. 0 minihage/ mini hook |
| 19 | 038259 |
| 25 | 038260 |
| 28 | 038265 |

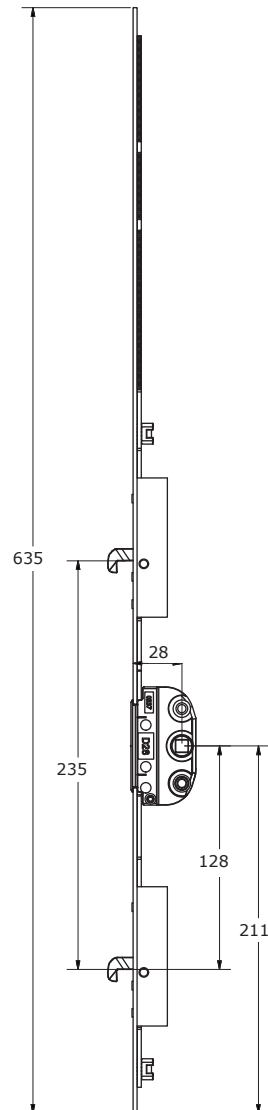

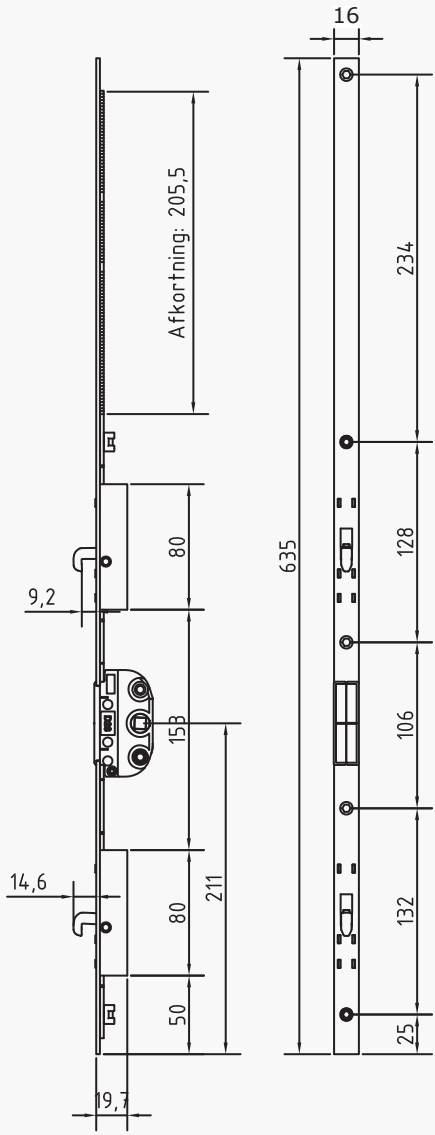

BREMSE & TILBEHØR

Brakes & Accessories

3.

BREMSEOVERFØRING

16 mm fladstolpe, sølv finish.

For kobling med kolvepaskviller.

Brake Connector

16 mm flat faceplate, silver finish.

For coupling with tongue espags.

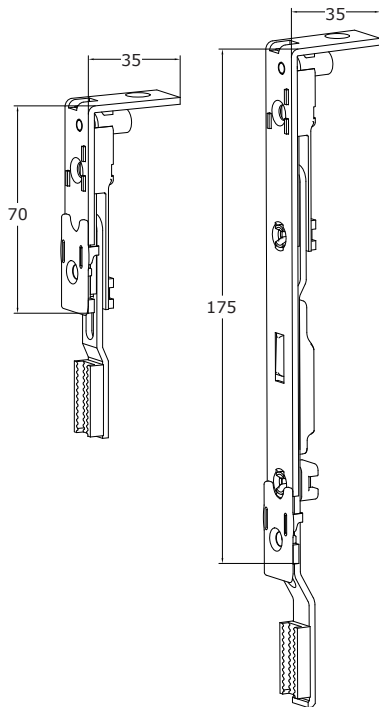
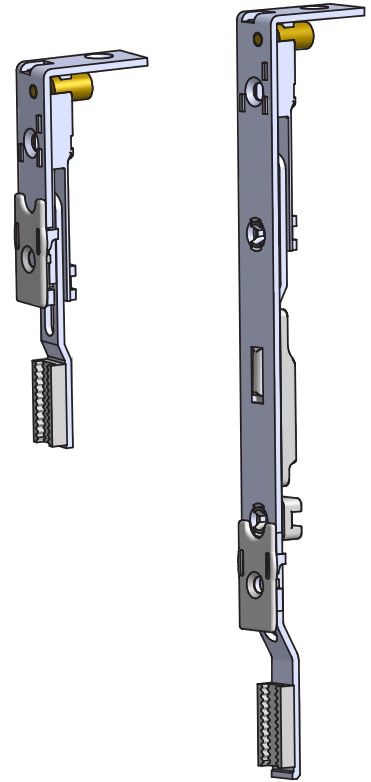

| ARTIKELNR. | | |
|------------------|-------------|-------------|
| Størrelse / Size | 12 mm kolve | 15 mm kolve |
| 70 mm u. kolve | 038272 | 038273 |
| 175 mm m. kolve | 038275 | 038276 |

BREMSEOVERFØRING M. PILZTAP

Bremseoverføring med pilz-tap passende for hhv. MILA-GARANT og SIEGENIA AF fortanding. 16 mm fladstolpe, sølv finish.

Brake Connector with Mushroom Cam

Brake connector with mushroom cam suitable for MILA-GARANT and SIEGENIA AF tothing. 16 mm flat faceplate, silver finish.

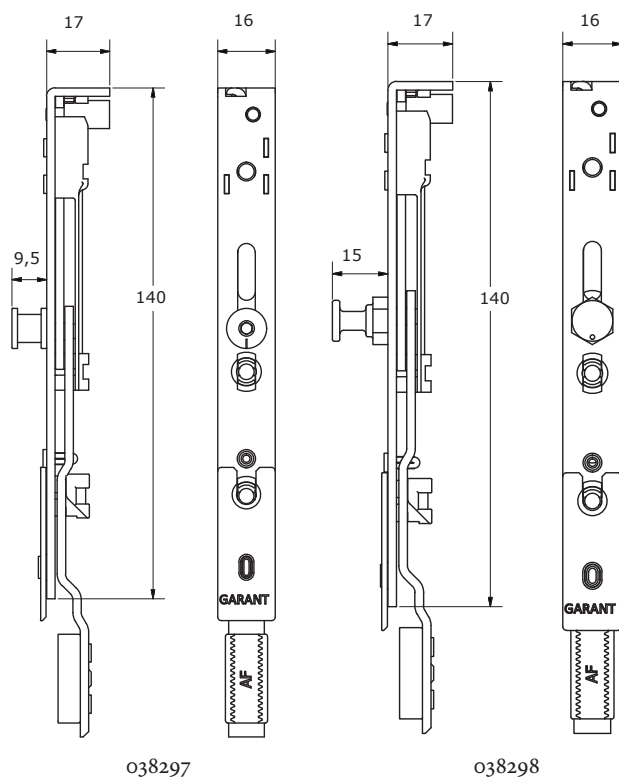
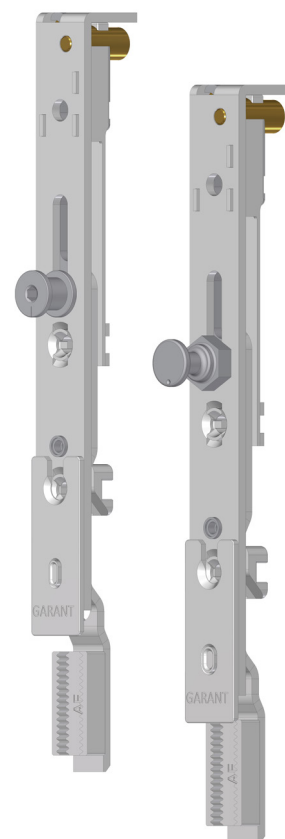

038297

038298

| ARTIKELNR. | | |
|----------------------------|------------------|-----------------|
| Type | 9,5 mm tap / cam | 15 mm tap / cam |
| AF fortanding / tothing | 038297 | 038298 |

HJØRNE M. MINI-HAGE

16 mm fladstolpe, sølv finish CR3+

Solid mini-hage, modstår sidetryk på op til 6.000N (600kg) uden brud eller afbøjning.

Corner with Mini Hooks

16 mm flat faceplate, silver finish CR13+

Strong mini hook, tested for side pressure up till 6000N (600 kgs) without break or bending.

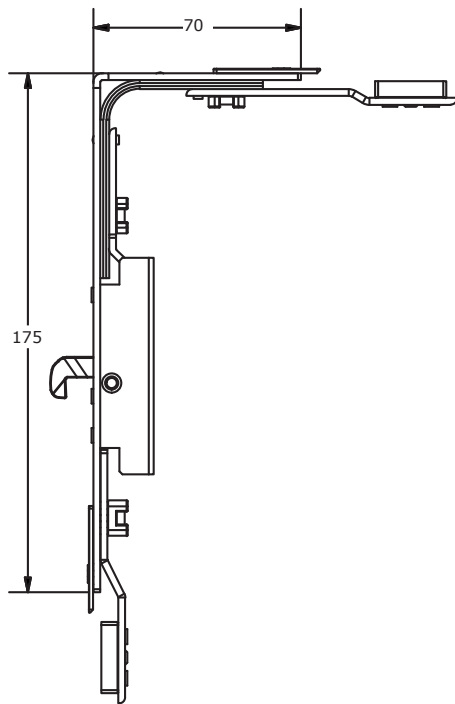
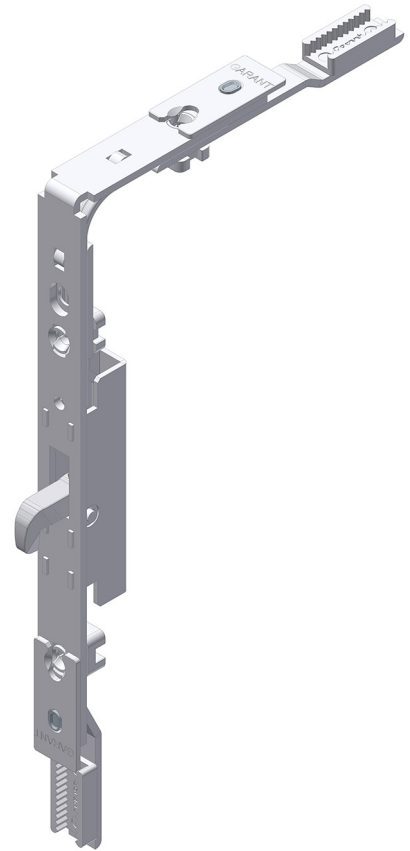

| ARTIKELNR. | |
|--------------|--------|
| Højre / RH | 038398 |
| Venstre / LH | 038399 |

GREBSBETJENT FRIKTIONSREMSE

Sølv finish. Passer til standard euronot.

For kobling med kolve- og minihage-paskviller via bremseoverføring.

Enkel montage med karmfæste



Handle Operated Brake

Silver finish. Fits standard Euro groove.

For coupling with tongue espags via brake connector.

Easy fitting by means of fixing bracket.

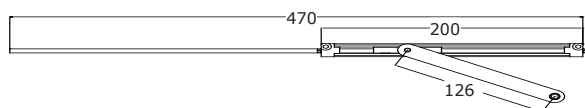

STR./SIZE 1

RFB/SRW: 280 - 500

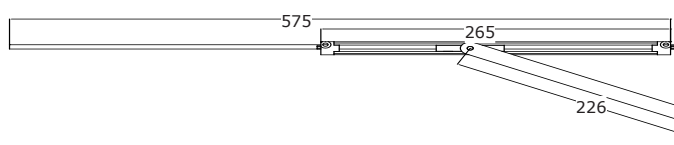

STR./SIZE 2

RFB/SRW: 501 - 700

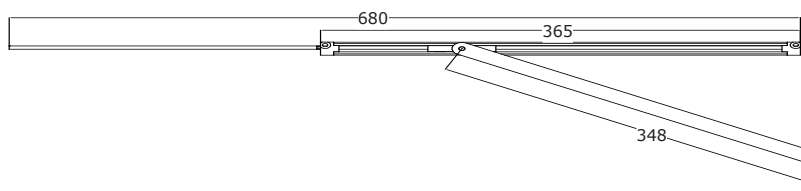

STR./SIZE 3

RFB/SRW: 701 - 900

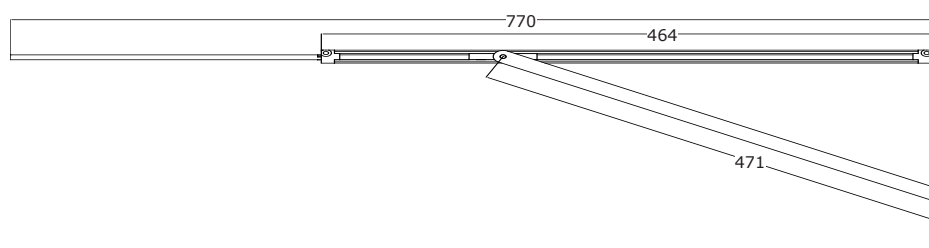

STR./SIZE 4

RFB/SRW: 901 - 1100

| ARTIKELNR. | |
|--|--------|
| Størrelse / Size | Nr. |
| 1 | 038280 |
| 2 | 038281 |
| 3 | 038282 |
| 4 | 038283 |
| Forlængerkit for str. 4, Extension for size 4230mm | 038284 |

GREBSBETJENT FRIKTIONSBREMSE M. BØRNESIKRING

Sølv finish. Passer til standard euronot.

For kobling med kolve- og minihage-paskviller
via bremseoverføring.

Enkel montage med karmfæste



Handle Operated Brake with Child Security Device

Silver finish. Fits standard Euro groove.

For coupling with tongue and mini hook espags via brake
connector .

Easy fitting by means of fixing bracket.

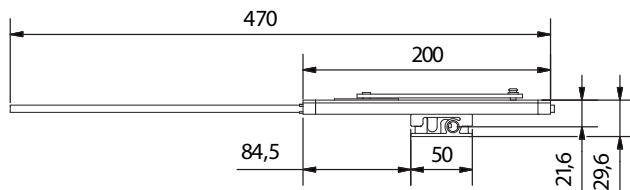

STR./SIZE 1
RFB/SRW: 280 – 500

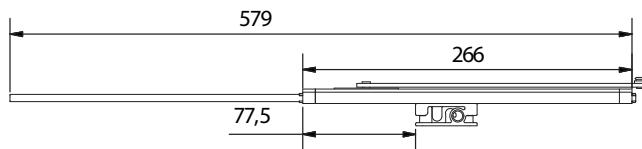

STR./SIZE 2
RFB/SRW: 501 – 700

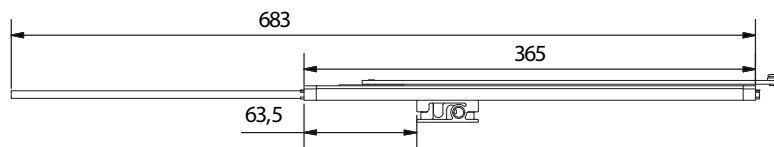

STR./SIZE 3
RFB/SRW: 701 - 900

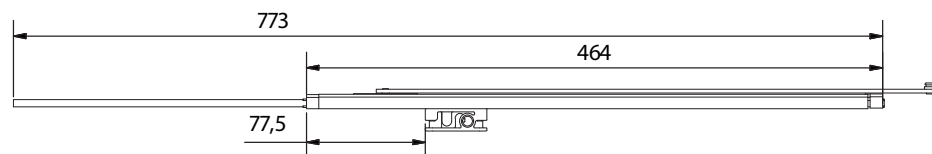

STR./SIZE 4
RFB/SRW: 901 - 1100



| ARTIKELNR. | |
|------------------|--------|
| Størrelse / Size | Nr. |
| 1 | 038286 |
| 2 | 038287 |
| 3 | 038288 |
| 4 | 038289 |

KARMFÆSTER

Fixing Brackets

Karmfæste til hhv. 9 x 16, 5 x 16 og 7 x 12 mm not. Anvendes sammen med friktionsbremse.

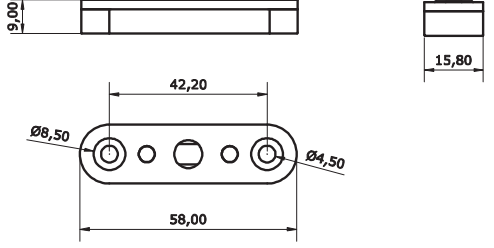
Fixing bracket on for 9 x 16, 15 x 16 and 7 x 12 mm groove.
Is used with brake

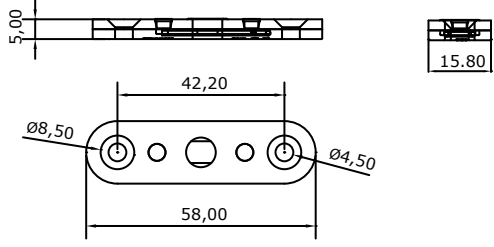
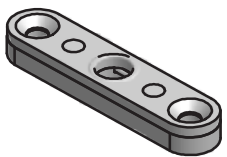
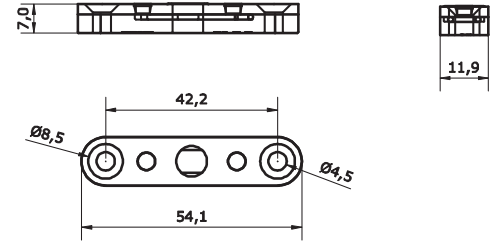
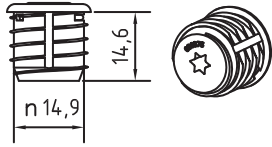
| | |
|--|--|
| <p><u>Karmfæste 9 x 16</u></p>  |  |
| <p><u>Karmfæste 5 x 16</u></p>  |  |
| <p><u>Karmfæste 7 x 12</u></p>  |  |
| <p><u>Karmfæste til iskruning</u> <u>Fixing Bracket Screw</u></p> |  |

| ARTIKELNR. | |
|------------------------|--------|
| 9 x 16 mm not / groove | 038290 |
| 5 x 16 mm not / groove | 038291 |
| 7 x 12 mm not / groove | 038292 |
| Skruer / Screw | 038375 |

FORLÆNGER- OG ENDESTYKKER

16 mm fladstolpe, sølv finish, for kobling med kolvepaskviller med både 12 og 15 mm kolvefremspring.

Extensions

16 mm flat faceplate, silver finish. For coupling with tongue espags with both 12 and 15 mm tongue projection.

ENDESTK. BUND
BOTTOM END PIECE

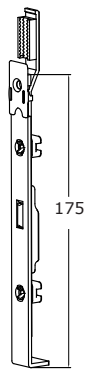

FORLÆNGERSTK. BUND
EXTENSION, BOTTOM

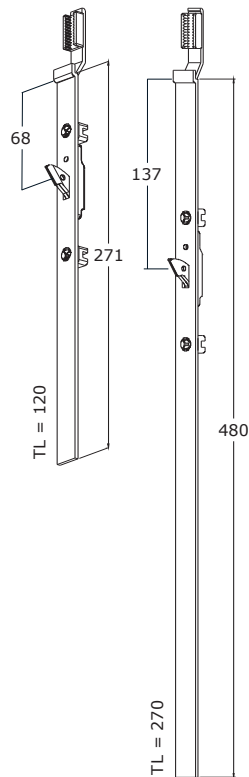

ENDESTK. TOP
TOP END PIECE

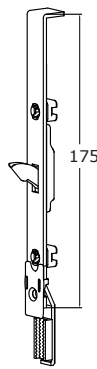

FORLÆNGERSTK. TOP
EXTENSION, TOP

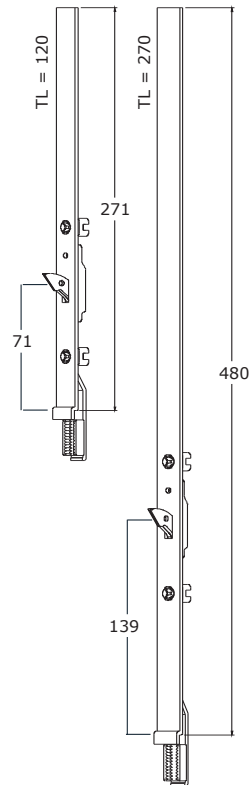

FORLÆNGERSTK. UDEN KOLVE
EXTENTION, NO TONGUE

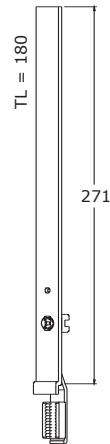

TL = TANDLÆNGDE / SERRATED

| ARTIKELNR. | | |
|-------------------|----------------------------|------------|
| Størrelse Size | Top / Bund Top / Bottom | Nr. No. |
| 175 | Top | 038270 |
| 175 | Bund | 038271 |
| 271 | Top | 038380 |
| 271 | Bund / Bottom | 038384 |
| 480 | Top | 038382 |
| 480 | Bund / Bottom | 038386 |
| 271 | Uden kolve No tongue | 038383 |

ENDESTYKKER TIL MINIHAGE-PASKVILLER

16 mm fladstolpe, sølv finish, for kobling med minihage-paskviller med 14,6 mm fremspring.

End Pieces for Mini Hook Espags

16 mm flat faceplate, silver finish. For coupling with mini hook espags with 14,6 mm tongue projection.

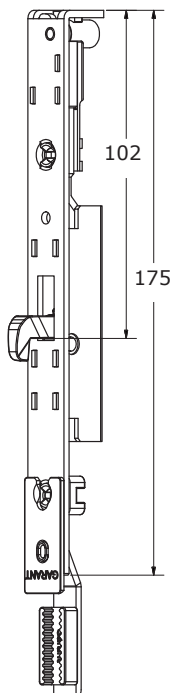

FORLÆNGER, TOP
M. BREMSEOVERFØRING

TOP END PIECE
W. BRAKE CONNECTOR

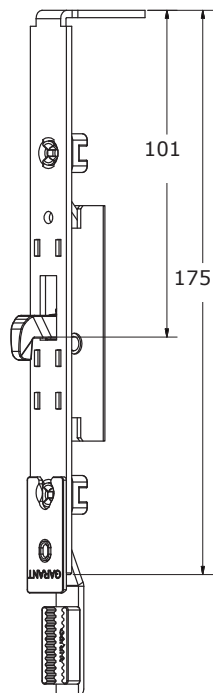

FORLÆNGER, TOP
U. BREMSEOVERFØRING

TOP END PIECE
WITHOUT CONNECTOR

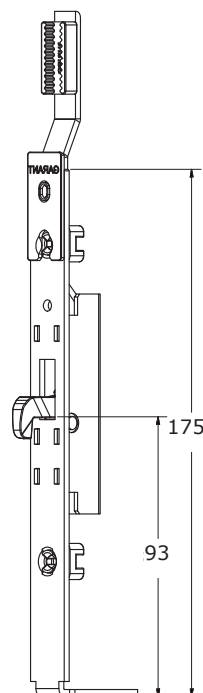

FORLÆNGER, BUND
U. BREMSEOVERFØRING

BOTTOM END PIECE
WITHOUT CONNECTOR

| ARTIKELNR. | | |
|----------------------------|-------------------------|------------|
| Top / Bund Top / Bottom | Overføring Connector | Nr. No. |
| Top | med /with | 038395 |
| Top | uden / without | 038396 |
| Bund | uden / without | 038397 |

PASKVILLER M. SI-TAP

Mushroom Espags

4.

RULLEPASKVILLER STR. 20 M. SIKKERHEDSTAP

16 mm fladstolpe, sølv finish. Låsekasse i støbt zink. 7 mm grebshul.

Dornmål: 19, 25, 28, 33, 40.

Paskvillen er forsynet med RBS, hvilket vil sige, at sikkerhedstappene i lukket stilling kun kan betjenes via grebet.

Mushroom Espag Size 20

16 mm flat faceplate. Silver finish.

Lock case in zinc diecast. 7 mm handle hole.

Backset: 19, 25, 28, 33, 40.

The lock cases are equipped with RBS, which means that the mushroom cams in closed position can be operated through the handle only.

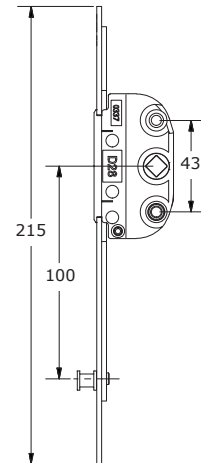

| ARTIKELNR. | | |
|--------------------|--------------------|------------|
| Dornmål Backset | Si-tap Mushroom | Nr. No. |
| 19 | 9 mm | 037600 |
| 25 | 9 mm | 037640 |
| 28 | 9 mm | 037660 |
| 33 | 9 mm | 037540 |

RULLEPASKVILLER STR. 28 M. SIKKERHEDSTAP

16 mm fladstolpe, sølv finish. Låsekasse i støbt zink. 7 mm grebshul.

Dornmål: 19, 25, 28, 33, 40.

Paskvillen er forsynet med RBS, hvilket vil sige, at sikkerhedstappene i lukket stilling kun kan betjenes via grebet.

Mushroom Espag Size 28

16 mm flat faceplate. Silver finish.

Lock case in zinc diecast. 7 mm handle hole.

Backset: 19, 25, 28, 33, 40.

The lock cases are equipped with RBS, which means that the mushroom cams in closed position can be operated through the handle only.

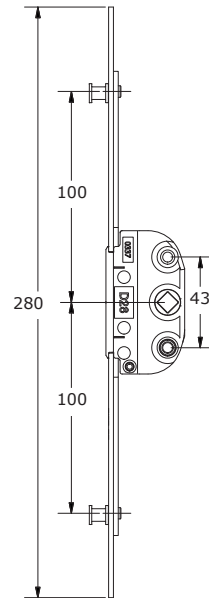

| ARTIKELNR. | | |
|--------------------|--------------------|------------|
| Dornmål Backset | Si-tap Mushroom | Nr. No. |
| 19 | 9 mm | 037602 |
| 25 | 9 mm | 037642 |
| 28 | 9 mm | 037662 |
| 33 | 9 mm | 037542 |

RULLEPASKVILLER STR. 40 M. SIKKERHEDSTAP

16 mm fladstolpe, sølv finish. Låsekasse i støbt zink. 7 mm grebshul.

Dornmål: 19, 25, 28, 33, 40.

Paskvillen er forsynet med RBS, hvilket vil sige, at sikkerhedstappene i lukket stilling kun kan betjenes via grebet.

Mushroom Espag Size 40

16 mm flat faceplate. Silver finish.

Lock case in zinc diecast. 7 mm handle hole.

Backset: 19, 25, 28, 33, 40.

The lock cases are equipped with RBS, which means that the mushroom cams in closed position can be operated through the handle only.

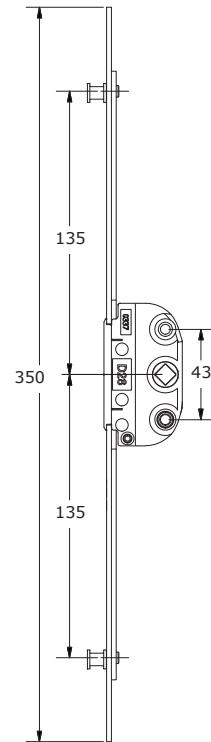

| ARTIKELNR. | | |
|--------------------|--------------------|------------|
| Dornmål Backset | Si-tap Mushroom | Nr. No. |
| 19 | 9 mm | 037604 |
| 25 | 9 mm | 037644 |
| 28 | 9 mm | 037664 |
| 33 | 9 mm | 037544 |

RULLEPASKVILLER STR. 60 M. SIKKERHEDSTAP

16 mm fladstolpe, sølv finish. Låsekasse i støbt zink. 7 mm grebshul.

Dornmål: 19, 25, 28, 33, 40.

Paskvillen er forsynet med RBS, hvilket vil sige, at sikkerhedstappene i lukket stilling kun kan betjenes via grebet.

Mushroom Espag Size 60

16 mm flat faceplate. Silver finish.

Lock case in zinc diecast. 7 mm handle hole.

Backset: 19, 25, 28, 33, 40

The lock cases are equipped with RBS, which means that the mushroom cams in closed position can be operated through the handle only.

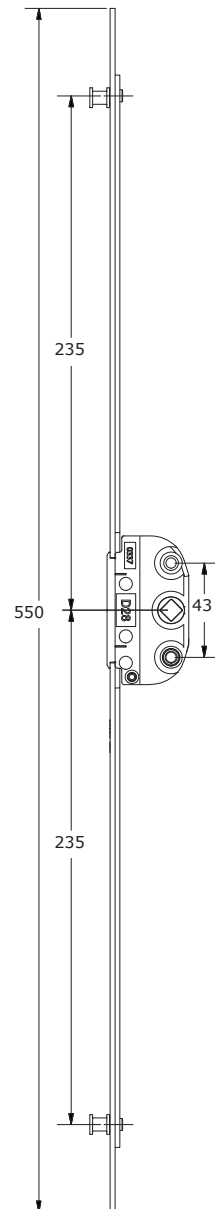

| ARTIKELNR. | | |
|--------------------|--------------------|------------|
| Dornmål Backset | Si-tap Mushroom | Nr. No. |
| 19 | 9 mm | 037606 |
| 25 | 9 mm | 037646 |
| 28 | 9 mm | 037666 |
| 33 | 9 mm | 037546 |

RULLEPASKVILLER STR. 80 M. SIKKERHEDSTAP

16 mm fladstolpe, sølv finish. Låsekasse i støbt zink. 7 mm grebshul.

Dornmål: 19, 25, 28, 33, 40.

Paskvillen er forsynet med RBS, hvilket vil sige, at sikkerhedstappene i lukket stilling kun kan betjenes via grebet.

Mushroom Espag Size 80

16 mm flat faceplate. Silver finish.

Lock case in zinc diecast. 7 mm handle hole.

Backset: 19, 25, 28, 33, 40.

The lock cases are equipped with RBS, which means that the mushroom cams in closed position can be operated through the handle only.

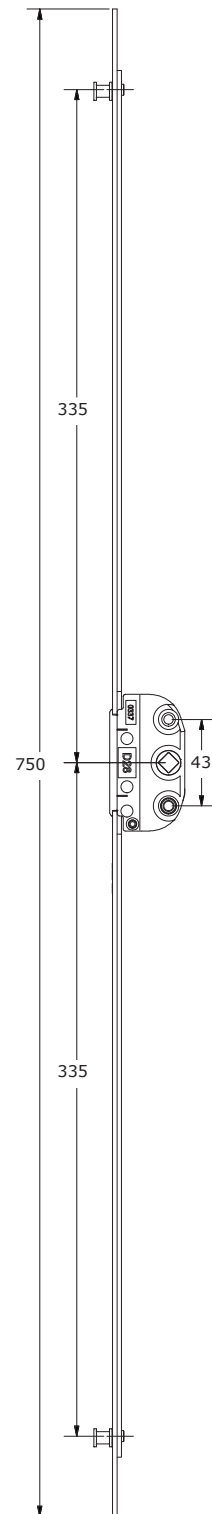

| ARTIKELNR. | | |
|--------------------|--------------------|------------|
| Dornmål Backset | Si-tap Mushroom | Nr. No. |
| 19 | 9 mm | 037608 |
| 25 | 9 mm | 037648 |
| 28 | 9 mm | 037668 |
| 33 | 9 mm | 037548 |

RULLEPASKVILLER STR. 100 M. SIKKERHEDSTAP

16 mm fladstolpe, sølv finish. Låsekasse i støbt zink. 7 mm grebshul.

Dornmål: 19, 25, 28, 33, 40.

Paskvillen er forsynet med RBS, hvilket vil sige, at sikkerhedstappene i lukket stilling kun kan betjenes via grebet.

Mushroom Espag Size 100

16 mm flat faceplate. Silver finish.

Lock case in zinc diecast. 7 mm handle hole.

Backset: 19, 25, 28, 33, 40

The lock cases are equipped with RBS, which means that the mushroom cams in closed position can be operated through the handle only.

| ARTIKELNR. | | |
|--------------------|--------------------|------------|
| Dornmål Backset | Si-tap Mushroom | Nr. No. |
| 19 | 9 mm | 037610 |
| 25 | 9 mm | 037650 |
| 28 | 9 mm | 037670 |
| 33 | 9 mm | 037550 |

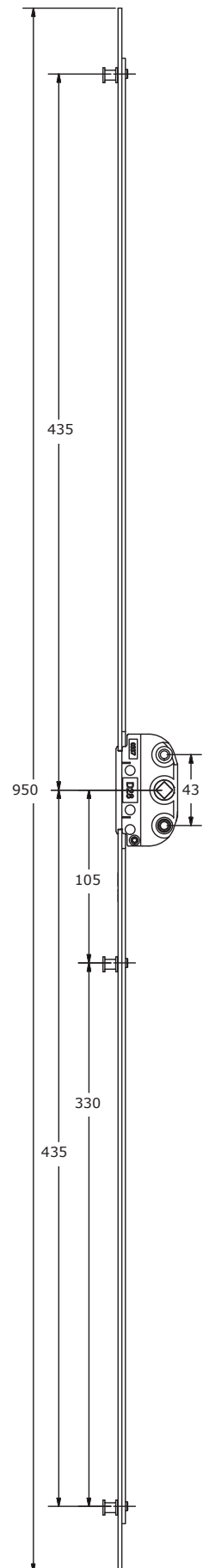

RULLEPASKVILLER STR. 120 M. SIKKERHEDSTAP

16 mm fladstolpe, sølv finish. Låsekasse i støbt zink. 7 mm grebshul.

Dornmål: 19, 25, 28, 33, 40.

Paskvillen er forsynet med RBS, hvilket vil sige, at sikkerhedstappene i lukket stilling kun kan betjenes via grebet.

Mushroom Espag Size 120

16 mm flat faceplate. Silver finish.

Lock case in zinc diecast. 7 mm handle hole.

Backset: 19, 25, 28, 40.

The lock cases are equipped with RBS, which means that the mushroom cams in closed position can be operated through the handle only.

| ARTIKELNR. | | |
|--------------------|--------------------|------------|
| Dornmål Backset | Si-tap Mushroom | Nr. No. |
| 19 | 9 mm | 037612 |
| 25 | 9 mm | 037652 |
| 28 | 9 mm | 037672 |
| 33 | 9 mm | 037552 |

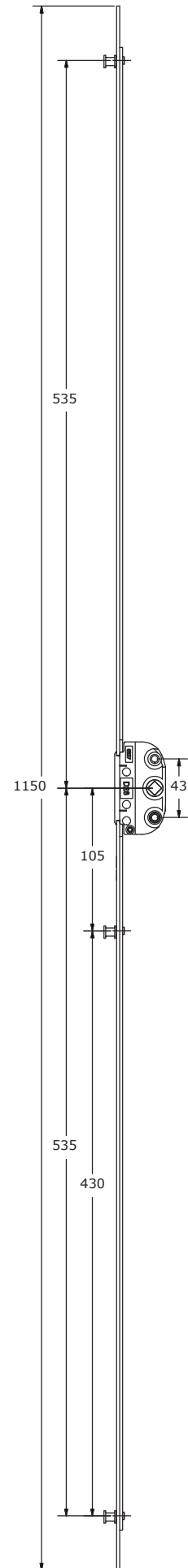

RULLEPASKVILLER

RULLEPASKVILLER STR. 140 M. SIKKERHEDSTAP

16 mm fladstolpe, sølv finish. Låsekasse i støbt zink. 7 mm grebshul.

Dornmål: 19, 25, 28, 33, 40.

Paskvillen er forsynet med RBS, hvilket vil sige, at sikkerhedstappene i lukket stilling kun kan betjenes via grebet.

Mushroom Espag Size 140

16 mm flat faceplate. Silver finish.

Lock case in zinc diecast. 7 mm handle hole.

Backset: 19, 25, 28, 33, 40.

The lock cases are equipped with RBS, which means that the mushroom cams in closed position can be operated through the handle only.

| ARTIKELNR. | | |
|--------------------|--------------------|------------|
| Dornmål Backset | Si-tap Mushroom | Nr. No. |
| 19 | 9 mm | 037614 |
| 25 | 9 mm | 037654 |
| 28 | 9 mm | 037674 |
| 33 | 9 mm | 037554 |

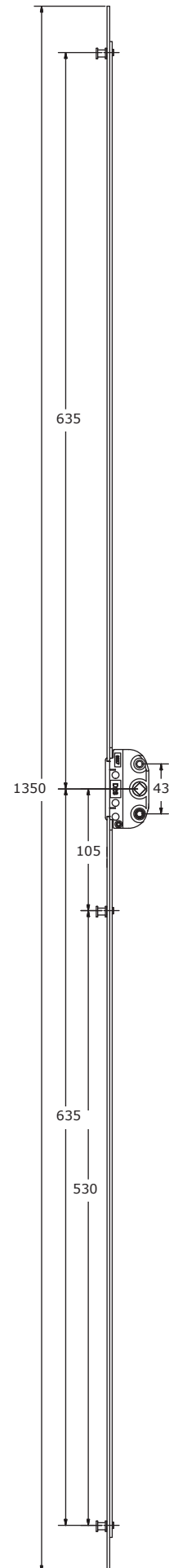

MONITORING

Mounting

5.

MONTERINGSVEJLEDNING

Monteringsvejledning for elementer i træ og plast **uden overfals**, 4-5 mm falsluft, med beslagnot 9x16, 5x16 eller 7x12 mm i karm samt MILA GARANT bremseoverføring II.

Mål for placering af bremse og karmfæste er baseret på hængsel med en omdrejningsakse på

11 mm fra udvendig karmside og centerlinie midt i falsluft. Hvis omdrejningspunktet ændres som følge af anden hængselgeometri, vil åbningsvinklen ændre sig. Mål for placering skal da korrigeres tilsvarende.

Mounting Instruction

Mounting instruction for elements in timber and PVC **without rebate**, 4-5 mm air gap, and with a 9x16, 5x16 or 7x12 mm fitting groove in the frame and a MILA GARANT Brake Connector II.

Measurements of the position of brake and fixing bracket are based on hinges with an axis of rotation of 11 mm from surface of frame and a centre line between sash and frame. If the turning point differs from this, the opening angle will change. Consequently, measurements have to be corrected accordingly.

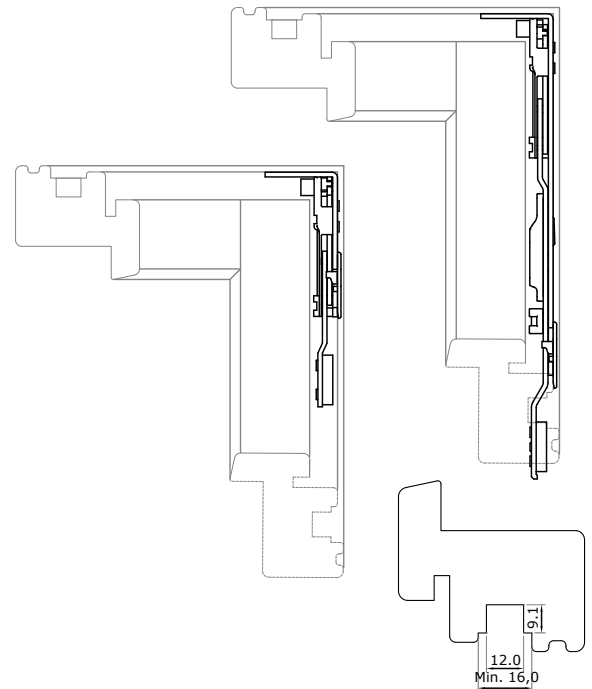

EKSEMPEL PÅ TRÆRAMME MED EURONOT.

EXAMPLE OF TIMBER FRAME WITH EURO GROOVE

| MÅLSKEMA FOR BREMSE / KARMFÆSTE | | | | |
|---------------------------------|-------------------------|-------------------------|-------------------------|--------------------------|
| | BREMSE 1 Brake 1 | BREMSE 2 Brake 2 | BREMSE 3 Brake 3 | BREMSE 4 Brake 4 |
| | RFB/RBW 285 - 500 mm | RFB/RBW 451 - 700 mm | RFB/RBW 651 - 900 mm | RFB/RBW 851 - 1100 mm |
| A (mm) | 50 | 151 | 201 | 270 |
| B (mm) | 25 | 120 | 214 | 325 |

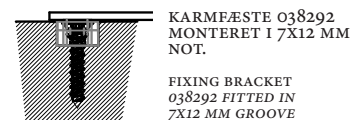

MONTERING:

1. Rundstang afkortes i MILA GARANT klipper eller andet egnet klippeværktøj. For at sikre let samling mellem rundstang og bremsoverføring fjernes grater efter klipning. Man kan også med fordel lave en let tilspidsning af de yderste 2 mm.

Afkortning af rundstang (drejende del):
Længde C = RFB - B mål - 10 mm.
2. Overgang og bremse samles og placeres i noten hen over øverste hjørne. Beslagdelene fast-skrues, dog endnu ikke laskepladen.
3. Den afkortede paskvil placeres og samles med overgangen. Både trækstangen på paskvillen og tandskoen skal stå i nederst mulige stilling. Forbind tandstang i tandsko, og luk med laskepladen, som skydes hen over samlingen. Skrue isættes.

MOUNTING:

1. Shorten the round rod in the MILA GARANT cutter or any other suitable cutting device. To ensure easy connection between rod and converter, all burrs from the cropping must be removed. It is also a further advantage to make a leading edge size 2 mm.

Shortening of the round rod (rotating part):
Length C = RFB - B Dimension - 10 mm.
2. Converter and brake are connected and placed in the groove across the top corner. The parts are fixed by screws. However, do not yet fix the cover plate.
3. Insert the espag after this has been cut to length. Connect it to the converter after securing the correct position of both the shoe and pulling rod, both are to be in the maximum downward position. Slide the cover plate over the joint and fix it with a screw.

VEDLIGEHOLDELSE

Maintenance

6.

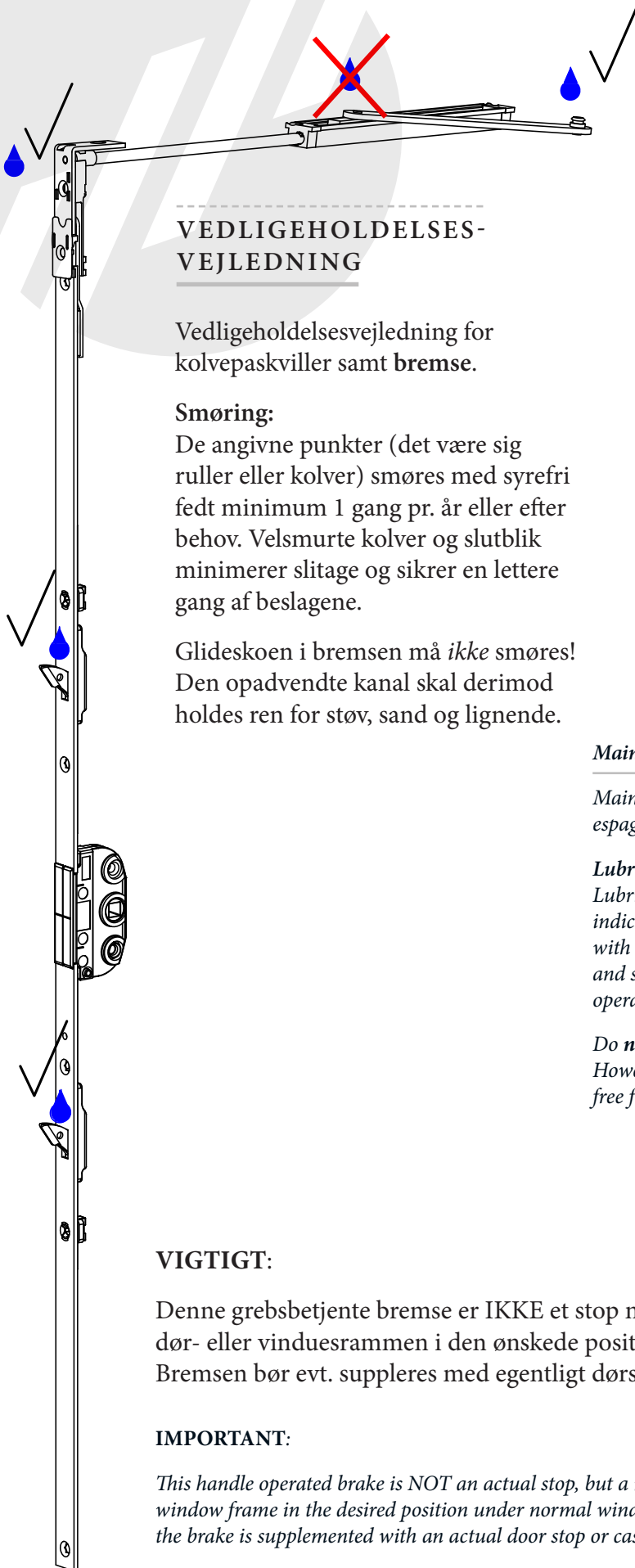

VEDLIGEHOEDELSSES- VEJLEDNING

Vedligeholdelsesvejledning for kolvepaskviller samt **bremse**.

Smøring:

De angivne punkter (det være sig ruller eller kolver) smøres med syrefri fedt minimum 1 gang pr. år eller efter behov. Velsmurte kolver og slutblik minimerer slitage og sikrer en lettere gang af beslagene.

Glideskoen i bremsen må *ikke* smøres! Den opadvendte kanal skal derimod holdes ren for støv, sand og lignende.

Maintenance Instruction

Maintenance instruction for cam and tongue espags and brakes.

Lubrication:

Lubricate all cams/tongues and strikers as indicated on the drawing at least once a year with acid-free grease. Well lubricated tongues and strikers minimise wear and tear, and ease operation.

*Do **not** lubricate the brake shoe! However, the upward facing channel must be kept free from dust, sand, etc.*

VIGTIGT:

Denne grebsbetjente bremse er IKKE et stop men alene beregnet til at fastholde dør- eller vinduesrammen i den ønskede position under normale vindforhold. Bremsen bør evt. suppleres med egentligt dørstop eller stormkrog.

IMPORTANT:

This handle operated brake is NOT an actual stop, but a means to hold the door or window frame in the desired position under normal wind conditions. We recommend the brake is supplemented with an actual door stop or casement hook.

MILA BESLAG A/S

H C Ørsteds Vej 18
DK-3000 Helsingør
Danmark
T. +45 49 13 99 00
E. info@mila.dk
www.mila.dk

MILA Baltics UAB

Kirtimu 59a
LT-02244 Vilnius
Lithuania
T. +370 5 2603200
E. info@mila.lt
www.mila.lt